

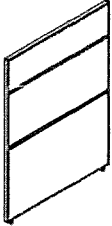



Assembly Instruction

Part List

SEQ	PICTURE	MODEL	QTY	Remarks
1				
2				
3		Joining Pole		
4				
5		Desk Brackets		
6		4x16mm screw		
7				

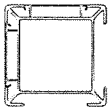
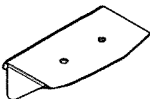
IMPORTANT NOTE:

- Place all parts on a clean and smooth surface such as a rug or carpet to avoid the parts from being scratched.
- Check to be sure that you have all parts and hardware.
- Remove all wrapping materials, including staples & packing straps before you start to assemble.
- Don't tighten all screws/bolts until all completely assembled.
- Keep all hardware parts out of reach of children

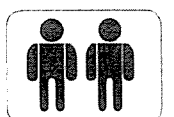

Assembly Instruction



About 8 Mins
Assembly Time

EASY Assembly
Without Tools

STEP1

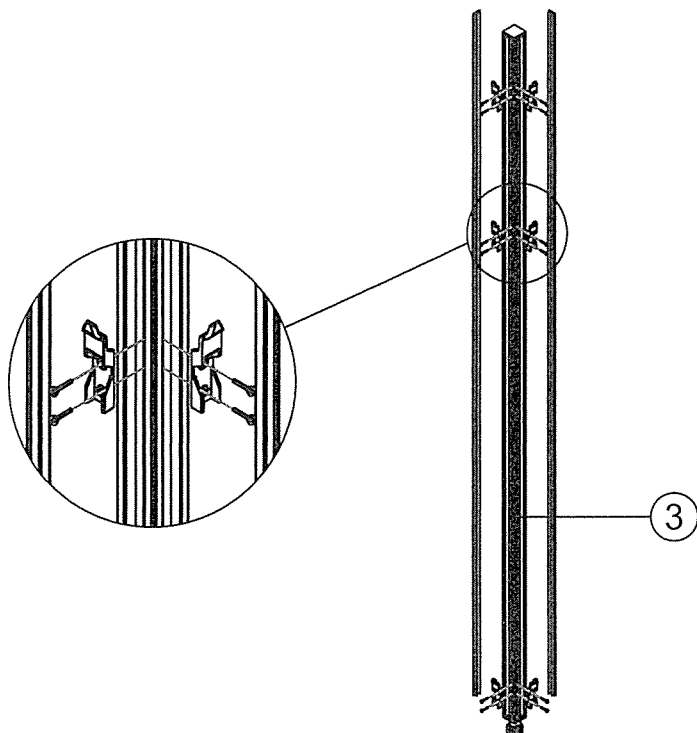

STEP2

Connect panel 1 to L joining Pole.

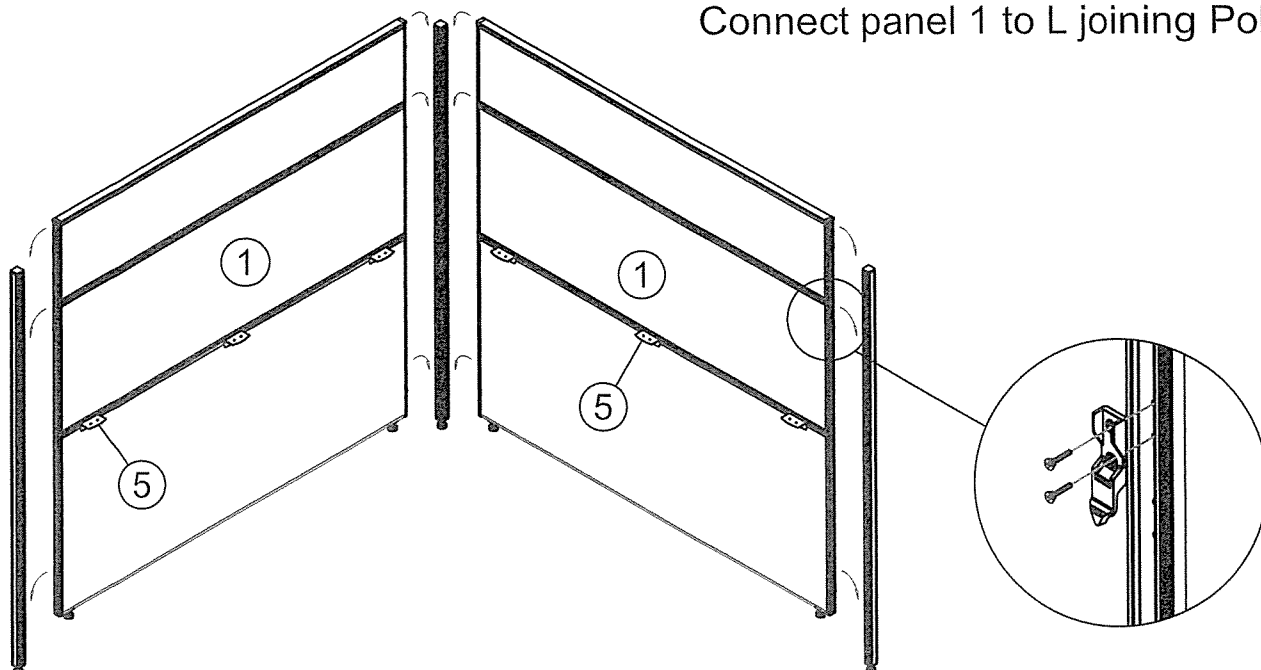

IMPORTANT NOTE:

- Place all parts on a clean and smooth surface such as a rug or carpet to avoid the parts from being scratched.
- Check to be sure that you have all parts and hardware.
- Remove all wrapping materials, including staples & packing straps before you start to assemble.
- Don't tighten all screws/bolts until all completely assembled.
- Keep all hardware parts out of reach of children

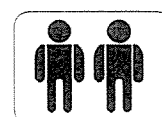

Assembly Instruction



EASY Assembly
Without Tools

STEP3

Connect panel 2 to L joining Pole.

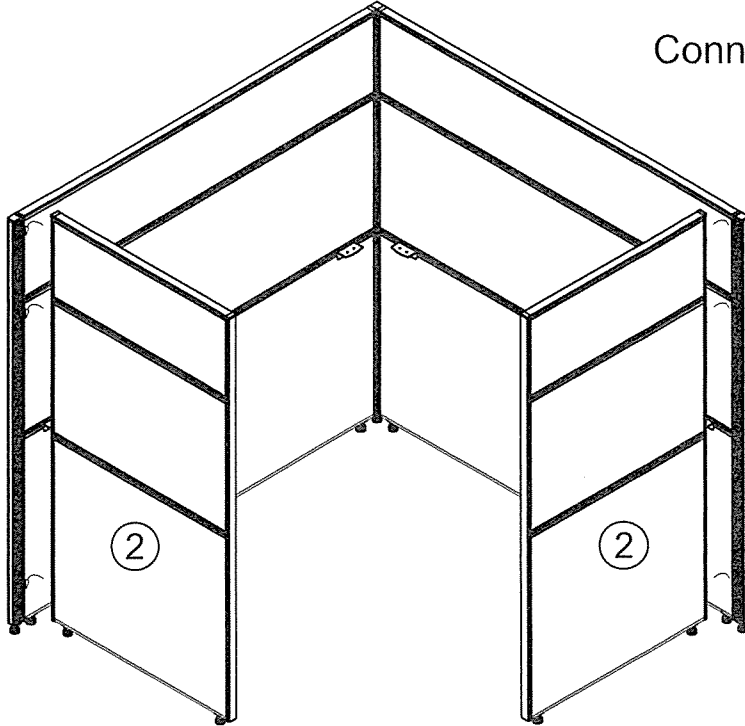

STEP4

Connect top 6 to panels using brackets.

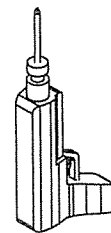
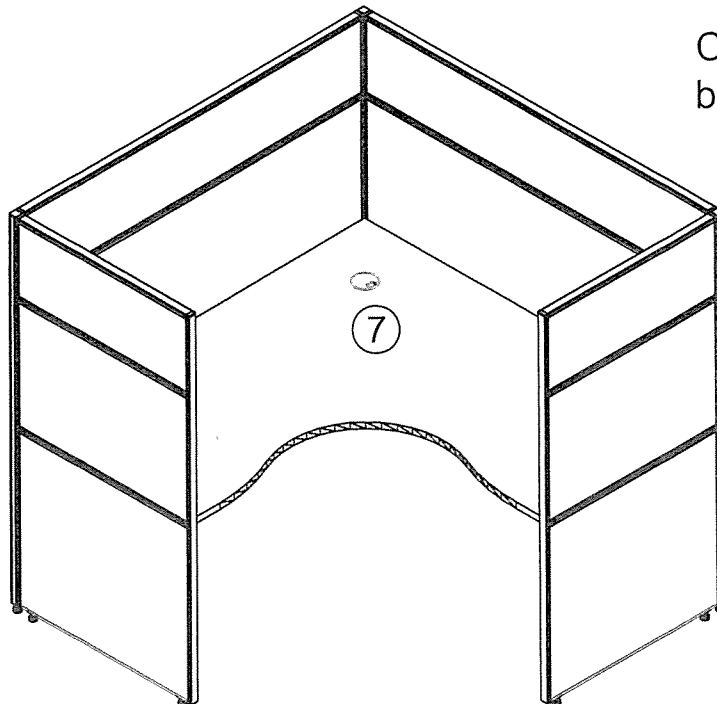

Notes: Use power drill to connect
desk top to brackets

IMPORTANT NOTE:

- Place all parts on a clean and smooth surface such as a rug or carpet to avoid the parts from being scratched.
- Check to be sure that you have all parts and hardware.
- Remove all wrapping materials, including staples & packing straps before you start to assemble.
- Don't tighten all screws/bolts until all completely assembled.
- Keep all hardware parts out of reach of children

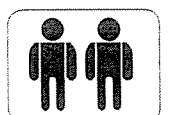

Assembly Instruction

Assembly Instruction



EASY Assembly
Without Tools

About 8 Mins
Assembly Time

Part List

SEQ	PICTURE	MODEL	QTY	Remarks
1				
2				
3				
4				
5				
6				
7				

STEP1

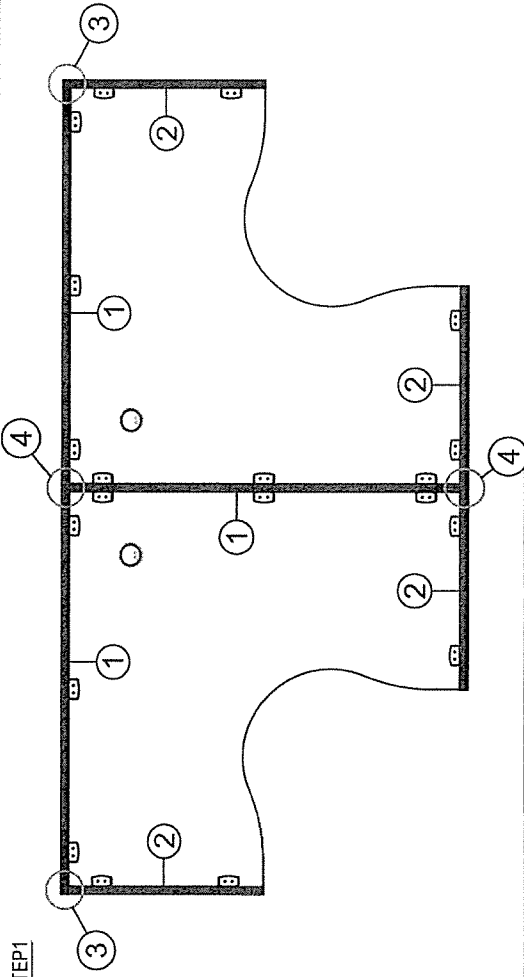

STEP2

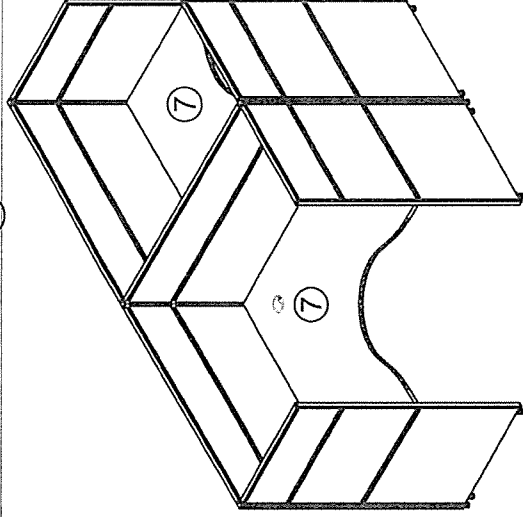

IMPORTANT NOTE:

- Place all parts on a clean and smooth surface such as a rug or carpet to avoid the parts from being scratched.
- Check to be sure that you have all parts and hardware.
- Remove all wrapping materials, including staples & packing straps before you start to assemble.
- Don't tighten all screws/bolts until all completely assembled.
- Keep all hardware parts out of reach of children



IMPORTANT NOTE:

- Place all parts on a clean and smooth surface such as a rug or carpet to avoid the parts from being scratched.
- Check to be sure that you have all parts and hardware.
- Remove all wrapping materials, including staples & packing straps before you start to assemble.
- Don't tighten all screws/bolts until all completely assembled.
- Keep all hardware parts out of reach of children









Assembly Instruction

Assembly Instruction

Part List

About 8 Mins
Assembly Time

SEQ	PICTURE	MODEL	QTY	Remarks
1				
2				
3				
4				
5				
6				
7				

IMPORTANT NOTE:

- Place all parts on a clean and smooth surface such as a rug or carpet to avoid the parts from being scratched.
- Check to be sure that you have all parts and hardware.
- Remove all wrapping materials, including staples & packing straps before you start to assemble.
- Don't tighten all screws/bolts until all completely assembled.
- Keep all hardware parts out of reach of children



STEP1

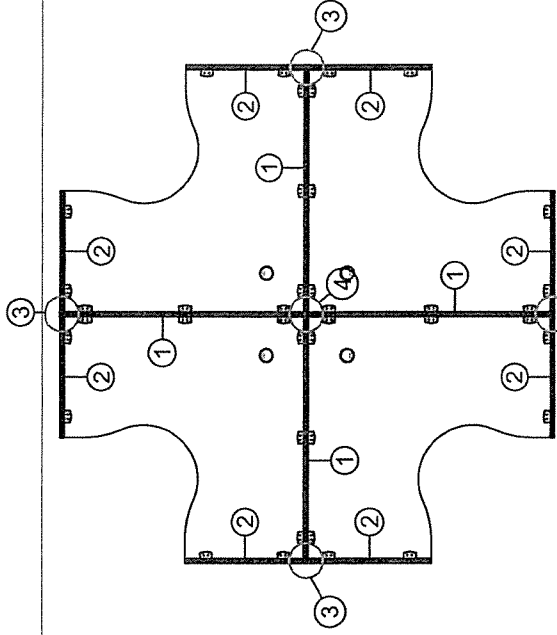

STEP2

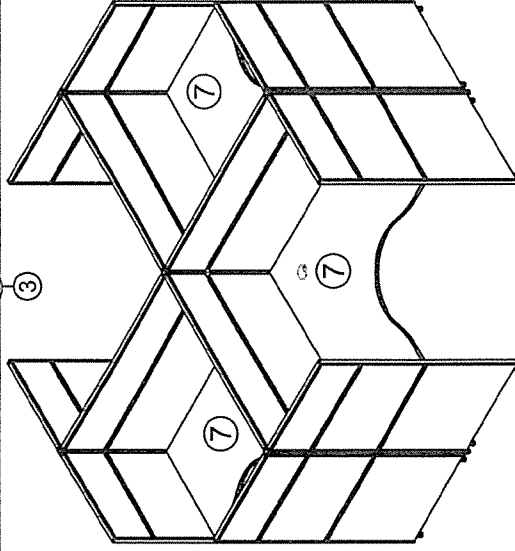

IMPORTANT NOTE:

- Place all parts on a clean and smooth surface such as a rug or carpet to avoid the parts from being scratched.
- Check to be sure that you have all parts and hardware.
- Remove all wrapping materials, including staples & packing straps before you start to assemble.
- Don't tighten all screws/bolts until all completely assembled.
- Keep all hardware parts out of reach of children



EASY Assembly
Without Tools